

TECHNICAL DETAILS:

- 1) ALL DIMENSIONS ARE IN mm.
- 2) GENERAL TOLERANCES : ±3%.
- 3) ALL FERROUS PARTS HOT DIP GALVANISED & SPRING WASHER ELECTRO GALVANISED AS PER POWERGRID SPECIFICATION.
- 4) ALL DIMENSIONS ARE AFTER GALVANISATION EXCEPT DRILLED HOLES.
- 5) HARDWARE TOLERANCES ON LENGTH ±2%.

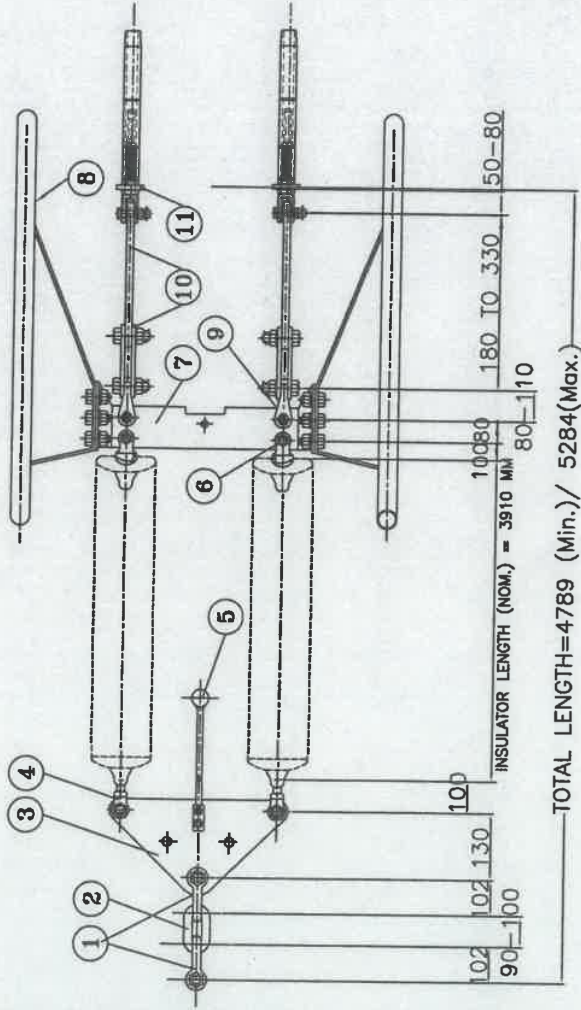

POWER GRID CORPORATION OF INDIA LIMITED
(A GOVERNMENT OF INDIA ENTERPRISE)



TITLE:- 400 KV DOUBLE TENSION INSULATOR STRING FOR TWIN MOOSE ACSR CONDUCTOR, UTS-320 KN

CLEARED BY

<i>[Signature]</i> SR. GM (ENGG-TL)	<i>[Signature]</i> CGM (ENGG-TL)	<i>[Signature]</i> ED (ENGG)
19-11-19	21-11-19	<i>[Signature]</i> GM (ENGG-TL)
DATE	MGR. (ENGG-TL)	ED (ENGG)

DRG. NO.:- CC:ENGG:TL/HW/400 KV/TWIN/DT

Sr. No.	DESCRIPTION	PART NO.	UTS	QTY.	REF	DRG: CC: ENGG: TL/HW
11	COMPRESSION DEADEND	CDE-MOOSE	----	2	CDE-002	
10	SAG ADJUSTABLE PLATE	SAP-160-01	160 KN	2 SET	SAP-001	
9	CLEVIS EYE	CE-160-01	160 KN	2	CE-001	
8	CORONA RING	CR-400-03A	----	2	CR-001	
7	YOKE PLATE	YP-RT-320-03	320 KN	1	YP-RT-001	
6	SOCKET CLEVIS	SC-175-01	175 KN	2	SC-001	
5	ARCING HORN (BALL)	AH-BL-02C	----	1	AHB-001	
4	BALL CLEVIS	BC-175-01A/ BC-175-01B	175 KN	2	BC-001	
3	YOKE PLATE	YP-TR-350-02	350 KN	1	YP-TR-001	
2	CHAIN LINK	CL-320-01	320 KN	1	CL-001	
1	ANCHOR SHACKLE	AS-350-02	350 KN	2	AS-001	

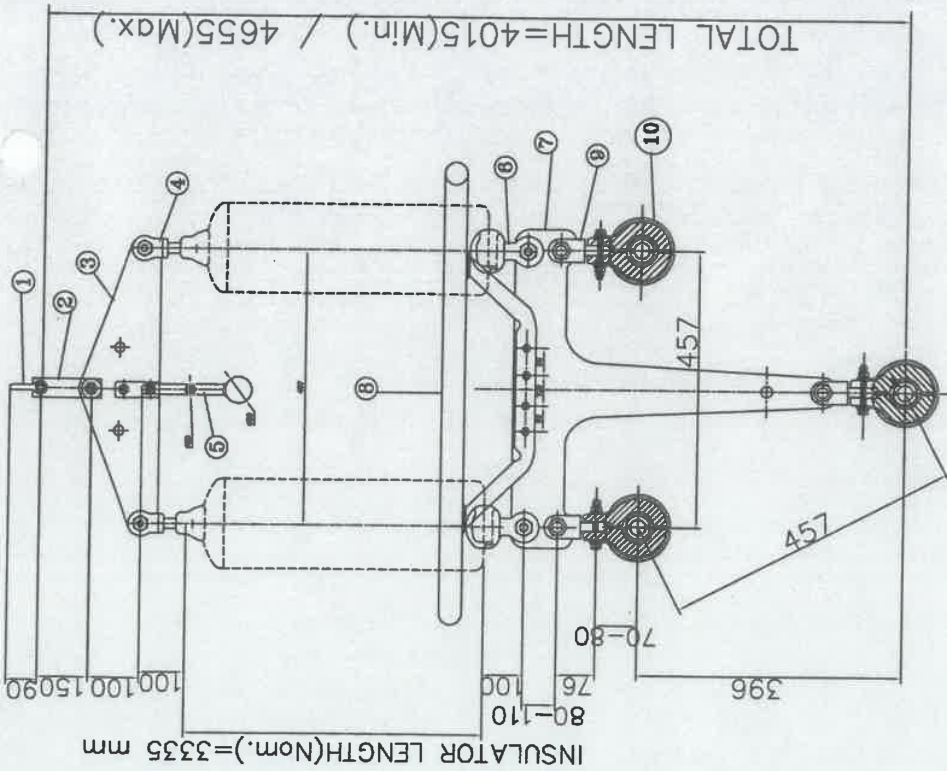

TECHNICAL TAILS:

- 1) ALL DIMENSIONS ARE IN mm.
- 2) GENERAL TOLERANCES : ±3%.
- 3) ALL FERROUS PARTS HOT DIP GALVANISED & SPRING WASHER ELECTRO GALVANISED AS PER POWERGRID SPECIFICATION.
- 4) ALL DIMENSIONS ARE AFTER GALVANISATION EXCEPT DRILLED HOLES.
- 5) HARDWARE TOLERANCES ON LENGTH ±2%.



**POWER GRID CORPORATION
OF INDIA LIMITED**
(A GOVERNMENT OF INDIA ENTERPRISE)

**TITLE:- 400 KV DOUBLE "I" SUSPENSION INSULATOR
STRING FOR TRIPLE ACSR "SNOWBIRD" CONDUCTOR.**

UTS-240 KN

CLEARED BY

 SR. GM (ENGG-TL)	 CGM (ENGG-TL)	 ED (ENGG)
14.11.19 DATE		

DRG. NO. :- CC:ENGG:TL/HW/400 KV/TRIPLE/DIS

Sr. No.	DESCRIPTION	PART NO.	UTS	QTY.	REF	DRG.	CC:ENGG:TL/HW
10	SUSPENSION CLAMP(A.G.S)	ACS-SNOWBIRD	70 KN	3			ACS-001
9	CLEVIS EYE	CE-90-01	90 KN	3			CE-001
8	CORONA RING	CR-400-02	----	1			CR-001
7	YOKE PLATE	YP-C-T-240-01	240 KN	1			YP-C-T-001
6	SOCKET CLEVIS	SC-120-01	120 KN	2			SC-001
5	ARCING HORN (BALL)	AH-BL-02B	----	2			AHB-001
4	BALL CLEVIS	BC-120-01	120 KN	2			BC-001
3	YOKE PLATE	YP-TR-240-02A	240 KN	1			YP-TR-001
2	Y-STRAP	YS-240-01	240 KN	1			YS-001
1	ANCHOR SHACKLE	AS-240-01	240 KN	1			AS-001

TECHNICAL DETAILS:

- 1) ALL DIMENSIONS ARE IN mm.
- 2) GENERAL TOLERANCES : $\pm 3\%$.
- 3) ALL FERROUS PARTS HOT DIP GALVANISED & SPRING WASHER ELECTRO GALVANISED AS PER POWERGRID SPECIFICATION.
- 4) ALL DIMENSIONS ARE AFTER GALVANISATION EXCEPT DRILLED HOLES.
- 5) HARDWARE TOLERANCES ON LENGTH $\pm 2\%$.

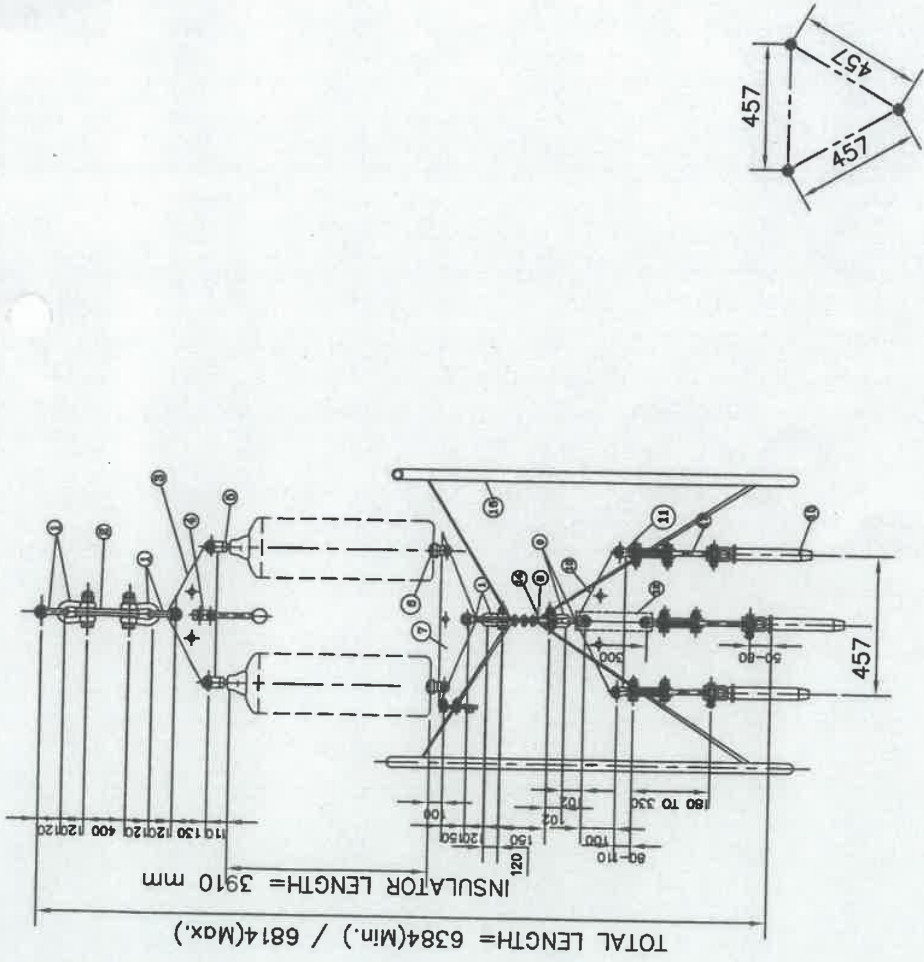

POWER GRID CORPORATION OF INDIA LIMITED
(A GOVERNMENT OF INDIA ENTERPRISE)



TITLE:- 400 KV. DOUBLE TENSION INSULATOR STRING FOR TRIPLE ACSR "SNOWBIRD" CONDUCTOR. UTS-420 KN

CLEARED BY

SR. GM (ENGG-TL) [Signature]
CGM (ENGG-TL) [Signature]
MGR (ENGG-TL) [Signature]
CH. MGR (ENGG-TL) [Signature]
ED (ENGG) [Signature]
GM (ENGG-TL) [Signature]

14.11.17
DATE

DRG. NO. :- CC:ENGG:TL/HW/400 KV/TRIPLE/DT

Sr. No.	DESCRIPTION	PART NO.	UTS	QTY.	REF
16	CORONA RING	CR-400-04B	---	2	CR-002
15	COMPRN. DEADEND	CODE-SNOWBIRD	1122 max.	3	CD-001
14	ANCHOR SHACKLE	AS-180-01	180 KN	2	AS-001
13	SAG ADJUSTABLE PLATE	SAP-160-01	160 KN	3	SAP-001
12	EXTENSION LINK	EL-160-01	160 KN	1	EL-001
11	CLEVIS EYE	CE-160-01	160 KN.	3	CE-001
10	YOKE PLATE	YP-TR-280-01	280 KN	1	YP-TR-001
9	ANCHOR SHACKLE	AS-350-02	350 KN	2	AS-001
8	YOKE PLATE	YP-TR-470-07	470 KN	1	YP-TR-001
7	YOKE PLATE	YP-TR-420-01	420 KN	1	YP-TR-001
6	SOCKET CLEVIS	SC-235-01	235 KN	2	SC-001
5	BALL CLEVIS	BC-235-01A	235 KN	2	BC-001
4	ARROW HORN (BALL)	AH-BL-02C	---	2	AHB-001
3	YOKE PLATE	YP-TR-470-02	470 KN	1	YP-TR-001
2	EXTENSION LINK	EL-420-01	420 KN	1	EL-001
1	ANCHOR SHACKLE	AS-470-01	470 KN	6	AS-001
			UTS		

DRG: CC:ENGG:TL/HW

TECHNICAL DETAILS:

- 1) ALL DIMENSIONS ARE IN MM.
- 2) GENERAL TOLERANCES : ±3%.
- 3) ALL FERROUS PARTS HOT DIP GALVANISED & SPRING WASHER ELECTRO GALVANISED AS PER POWERGRID SPECIFICATION.
- 4) ALL DIMENSIONS ARE AFTER GALVANISATION EXCEPT DRILLED HOLES.
- 5) HARDWARE TOLERANCES ON LENGTH ±2%.

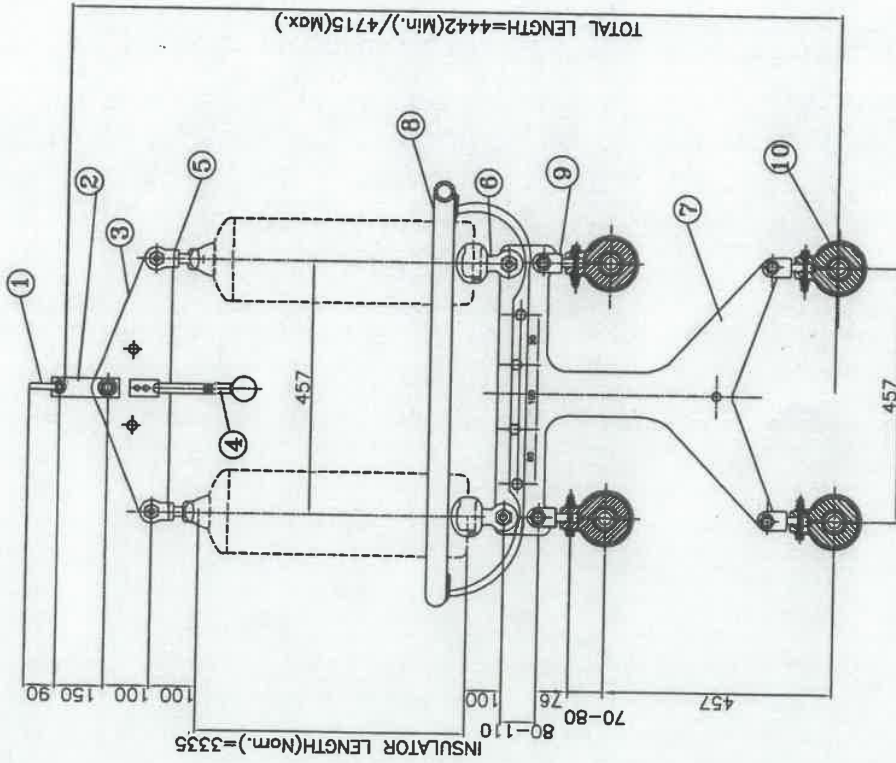

**POWER GRID CORPORATION
OF INDIA LIMITED**
(A GOVERNMENT OF INDIA ENTERPRISE)



**TITLE:- 400 KV DOUBLE I SUSPENSION STRING
FOR QUADRUPLE ACSR MOOSE CONDUCTOR.
UTS-240 KN**

CLEARED BY

<i>[Signature]</i> SR. GM (ENGG-TL)	<i>[Signature]</i> CGM (ENGG-TL)	<i>[Signature]</i> ED (ENGG)
14.11.19 DATE	<i>[Signature]</i> MGR. (ENGG-TL)	<i>[Signature]</i> CH. MGR. (ENGG-TL)

DRG. NO.:- CC:ENGG:TL/HW/400 KV/QUAD/DIS

Sr. No.	DESCRIPTION	PART NO.	UTS	QTY.	REF
10	SUSPENSION CLAMP(AGS)	AGS-MOUSE	70 KN	4	AGS-001
9	CLEVIS EYE	CE-90-01	90 KN	4	CE-001
8	CORONA RING	CR-400-02	----	1	CR-001
7	YOKE PLATE	YP-C-Q-240-01	240 KN	1	YP-C-Q-001
6	SOCKET CLEVIS	SC-120-01	120 KN	2	SC-001
5	BALL CLEVIS	BC-120-01	120 KN	2	BC-001
4	ARCING HORN (BALL)	AH-BL-02B	----	2	AHB-001
3	YOKE PLATE	YP-TR-240-02A	240 KN	1	YP-TR-001
2	Y-STRAP	YS-240-01	240 KN	1	YS-001
1	ANCHOR SHACKLE	AS-240-01	240 KN	1	AS-001
	DESCRIPTION	PART NO.	UTS	QTY.	REF
					DRG:CC:ENGG:TL/HW

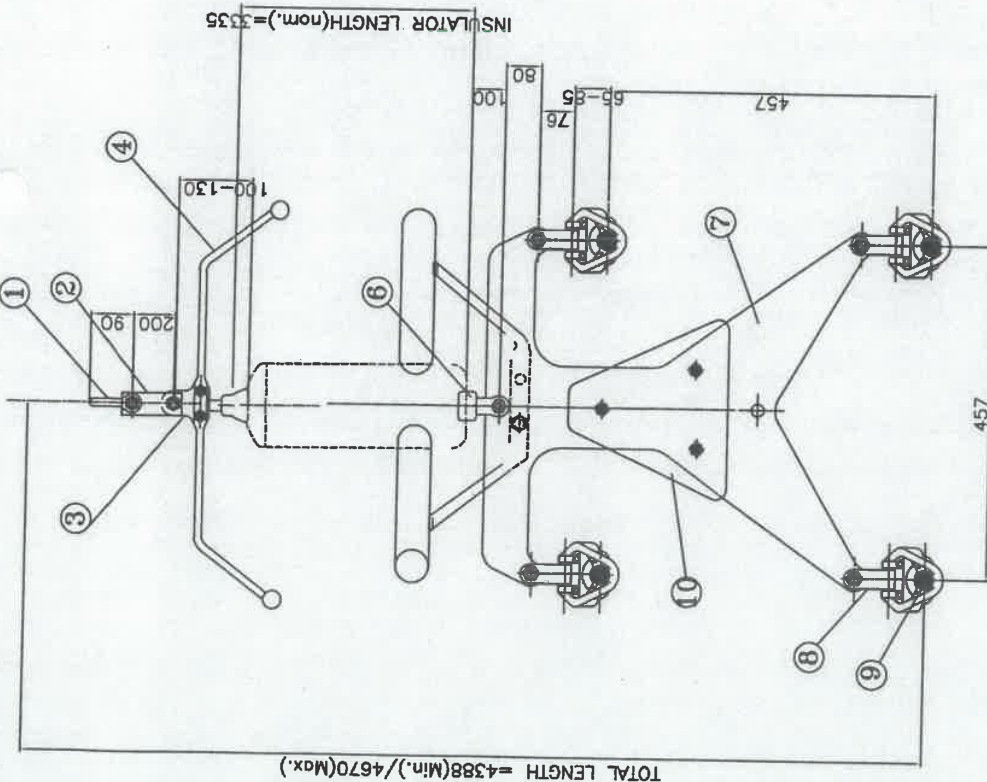

TECHNICAL DETAILS:

- 1) ALL DIMENSIONS ARE IN mm.
- 2) GENERAL TOLERANCES : ±3%.
- 3) ALL FERROUS PARTS HOT DIP GALVANISED & SPRING WASHER ELECTRO GALVANISED AS PER POWERGRID SPECIFICATION.
- 4) ALL DIMENSIONS ARE AFTER GALVANISATION EXCEPT DRILLED HOLES.
- 5) HARDWARE TOLERANCES ON LENGTH ±2%.

**POWER GRID CORPORATION
OF INDIA LIMITED**
(A GOVERNMENT OF INDIA ENTERPRISE)



**TITLE:- 400 KV SINGLE I SUSPENSION PILOT STRING
SUITABLE FOR QUADRUPL E ACSR MOOSE CONDUCTOR.**

UTS-120 KN

CLEARED BY

SR. CM (ENGG-TL)	CGM (ENGG-TL)	ED (ENGG)
14.11.19	21.02.19	
DATE	MGR. (ENGG-TL)	CH. MGR (ENGG-TL)

DRG. NO.:- CC:ENGG:TL/HW/400 KV/QUAD/SISP

Sr. No.	DESCRIPTION	PART NO.	UTS	QTY.	REF
10	COUNTER WEIGHT ASSEMBLY	CW-01	----	1	SET
9	SUSPENSION CLAMP	ENV-MDOSE	70 KN	4	ENV-001
8	CLEVIS EYE	CE-90-01	90 KN	4	CE-001
7	YOKE PLATE	YP-C-Q-120-02	120 KN	1	YP-C-Q-001
6	SOCKET CLEVIS	SC-120-01	120 KN	1	SC-001
5	CORONA RING	CR-400-01	----	1	CR-001
4	ARCING HORN (BALL)	AH-BL-01B	----	1	AHB-001
3	BALL EYE (HORN HOLDER)	BE-120-01	120 KN	1	BE-001
2	Y-STRAP	YS-120-01	120 KN	1	YS-001
1	ANCHOR SHACKLE	AS-120-01	120 KN	1	AS-001
	DESCRIPTION	PART NO.	UTS	QTY.	REF

DRG:CC:ENGG:TL/HW

TECHNICAL DETAILS:

- 1) ALL DIMENSIONS ARE IN MM.
- 2) GENERAL TOLERANCES : ±3%
- 3) ALL FERROUS PARTS HOT DIP GALVANISED & SPRING WASHER ELECTRO GALVANISED AS PER POWERGRID SPECIFICATION.
- 4) ALL DIMENSIONS ARE AFTER GALVANISATION EXCEPT DRILLED HOLES.
- 5) HARDWARE TOLERANCES ON LENGTH ±2%.
- 6) CLEVIS EYE NOT REQUIRED IF DEAD END ASSEMBLY INCLUDES ANCHOR SHACKLE

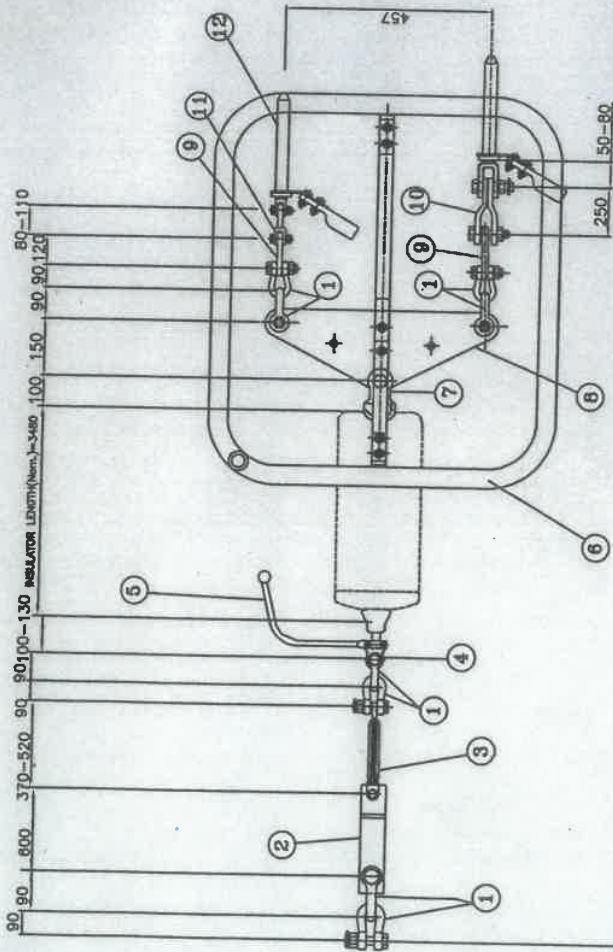

TOTAL LENGTH = 5873(Min.) / 6412(Max.)

Sr. No.	DESCRIPTION	PART NO.	UTS	QTY.	REF
13	SPACER (250 mm)	RS-250-MD05E	----	1	RS-001
12	COMPRESSION DEADEND	CDE-MD05E	----	4	CDE-002
11	CLEVIS EYE	CE-160-01	160 KN.	2	CE-001
10	Y-STRAPE	YS-160-02	160 KN.	2	YS-001
9	YOKE PLATE	YP-TR-80-01	80 KN.	2	YP-TR-001
8	YOKE PLATE	YP-TR-120-06	120 KN	1	YP-TR-001
7	SOCKET CLEVIS	SC-120-01	120 KN	1	SC-001
6	CORONA RING	CR-400-03C	----	2 SETS	CR-002
5	ARCING HORN (BALL)	AH-BL-03B	----	1	AHB-001
4	BALL EYE (HORN HOLDER)	BE-120-01	120 KN	1	BE-001
3	TURN BUCKLE	TB-120-01	120 KN	1	TB-001
2	Y-STRAPE	YS-120-02	120 KN	1	YS-001
1	ANCHOR SHACKLE	AS-120-01	120 KN	8	AS-001
	DESCRIPTION	PART NO.	UTS	QTY.	REF

POWER GRID CORPORATION OF INDIA LIMITED
(A GOVERNMENT OF INDIA ENTERPRISE)



TITLE:- 400 KV. SINGLE TENSION STRING SUITABLE FOR QUADRUPLE ACSR MOOSE CONDUCTOR. UTS-120 KN

CLEARED BY

SR. GM (ENGG-TL)

 CGM (ENGG-TL)

 MGR (ENGG-TL)

 ED (ENGG)

 GM (ENGG-TL)

14-11-19

DATE

DRG. NO. :- CC:ENGG:TL/HW/400 KV/QUAD/ST

TECHNICAL TAILS:

- 1) ALL DIMENSIONS ARE IN mm.
- 2) GENERAL TOLERANCES : ±3%.
- 3) ALL FERROUS PARTS HOT DIP GALVANISED & SPRING WASHER ELECTRO GALVANISED AS PER POWERGRID SPECIFICATION.
- 4) ALL DIMENSIONS ARE AFTER GALVANISATION EXCEPT DRILLED HOLES.
- 5) HARDWARE TOLERANCES ON LENGTH ±2%.

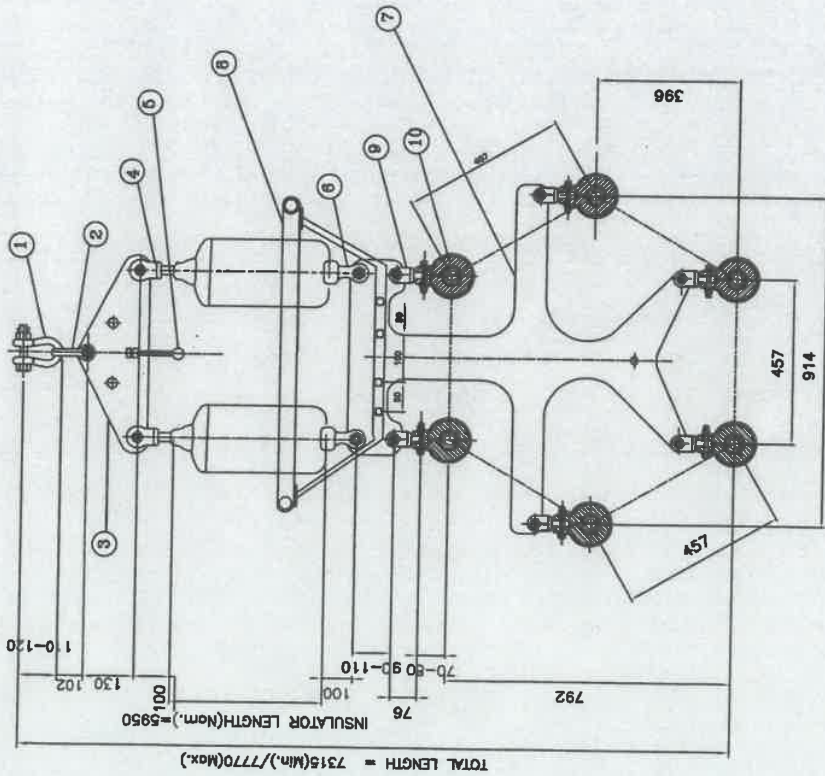

**POWER GRID CORPORATION
OF INDIA LIMITED**
(A GOVERNMENT OF INDIA ENTERPRISE)



TITLE:- 765 KV D/C (HEXA ZEBRA) DOUBLE "I" SUSPENSION STRING
FOR SIX BUNDLE "ZEBRA" ACSR CONDUCTOR
UTS-350 KN

CLEARED BY

SR. GM (ENGG-TL)
 14.11.19
 DATE

CGM (ENGG-TL)

CH. MGR (ENGG-TL)

ED (ENGG)

GM (ENGG-TL)

DRG. NO.:- CC:ENGG:TL/HW/765 KV/HEXA/DIS

Sr. No.	DESCRIPTION	PART NDI.	UTS	QTY.	REF
10	SUSPENSION CLAMP(AGS)	AGS-ZEBRA	70 KN	6	AGS-001
9	CLEVIS EYE	CE-90-01 / CE-70-01	90/70 KN	6	CE-001
8	CORONA RING	CR-765-02	----	1	CR-001
7	YOKE PLATE	YP-C-H-350-01	350 KN	1	YP-C-H-001
6	SOCKET CLEVIS	SC-175-01	175 KN	2	SC-001
5	ARCING HORN	AH-BL-02C	----	2	AHB-001
4	BALL CLEVIS	BC-175-01A / BC-175-01B	175 KN	2	BC-001
3	YOKE PLATE	YP-TR-350-02	350 KN	1	YP-TR-001
2	ANCHOR SHACKLE	AS-350-02	350 KN	1	AS-001
1	ANCHOR SHACKLE	AS-350-01	350 KN	1	AS-001
	DESCRIPTION	PART NDI.	UTS	QTY.	REF